

KIT DRAINAGE PLURY
Max. Gegendruck
15 BAR

PLURY	W1 9.0 TONS 1.0 - 2.0	W1 15.0 TONS 1.5 - 4.0	W1 15.0 TONS 1.5 - 4.0	W1 15.0 TONS 1.5 - 4.0	W1 27.0 TONS 4.0 - 6.5	W1 27.0 TONS 4.0 - 6.5	W1 27.0 TONS 4.0 - 6.5
A (mm)	480	525	525	525	680	680	680
B (mm)	366	430	430	430	540	540	540
C (mm)	210	210	210	210	272	272	272
D (mm)	290	290	290	290	395	395	395
Gewicht (Kg)	72	105	105	105	187	187	187
Motor (CC)	11	11	14	17	21	27	32
Öldurchsatz (L/Min)	23	23	31	37	45	57	69
Druck (BAR)	200/220	200/220	200/220	200/220	200/220	200/220	200/220
Vibrationsfrequenz (RPM)	2.130	2.130	2.153	2.173	2.133	2.111	2.143
Zentrifugalkraft (Kn)	9	15	15	15	27	27	27
Hertz	35	36	36	36	36	36	36
Max. Gegendruck (BAR)	15	15	15	15	15	15	15

PLURY	W1 40.0 TONS 5.0 - 6.5	W1 40.0 TONS 5.0 - 6.5	W1 40.0 TONS 5.0 - 6.5	W1 65.0 TONS 7.0 - 15.0	W1 65.0 TONS 7.0 - 15.0	W1 65.0 TONS 7.0 - 15.0	W1 95.0 TONS 8.0 - 22.0	W1 95.0 TONS 8.0 - 22.0	W1 95.0 TONS 8.0 - 22.0
A (mm)	680	680	680	840	840	840	840	840	840
B (mm)	540	540	540	670	670	670	670	670	670
C (mm)	272	272	272	332	332	332	332	332	332
D (mm)	395	395	395	515	515	515	515	515	515
Gewicht (Kg)	190	190	190	330	330	330	340	340	340
Motor (CC)	21	27	32	32	43	47	32	43	51
Öldurchsatz (L/Min)	45	57	69	69	93	101	69	93	101
Druck (BAR)	200/220	200/220	200/220	200/220	200/220	200/220	200/220	200/220	200/220
Vibrationsfrequenz (RPM)	2.133	2.111	2.143	2.133	2.111	2.143	2.133	2.111	2.143
Zentrifugalkraft (Kn)	40	40	40	65	65	65	95	95	95
Hertz	36	36	36	36	36	36	36	36	36
Max. Gegendruck (BAR)	15	15	15	15	15	15	15	15	15

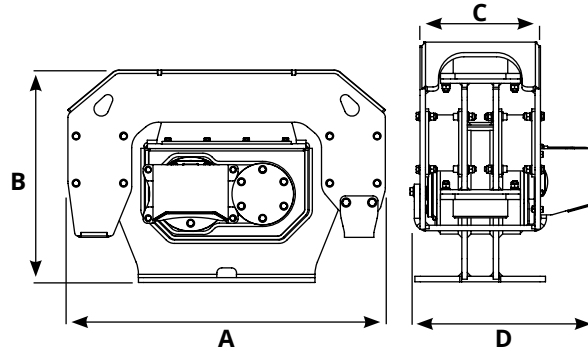

KIT DRAINAGE PLURY
Max. Gegendruck
15 BAR

PLURY	W2 60.0	W2 60.0	W2 60.0	W2 80.0	W2 80.0	W2 80.0	W2 100.0	W2 100.0	W2 100.0
	TONS 8.0 - 14.0	TONS 8.0 - 14.0	TONS 8.0 - 14.0	TONS 10.0 - 15.0	TONS 10.0 - 15.0	TONS 10.0 - 15.0	TONS 12.0 - 18.0	TONS 12.0 - 18.0	TONS 12.0 - 18.0
A (mm)	970	970	970	970	970	970	1030	1030	1030
B (mm)	650	650	650	650	650	650	735	735	735
C (mm)	330	330	330	330	330	330	395	395	395
D (mm)	490	490	490	490	490	490	560	560	560
Gewicht (Kg)	353	353	353	362	362	362	525	525	525
Motor (CC)	32	43	47	32	43	47	43	47	51
Öldurchsatz (L/Min)	69	93	101	69	93	101	93	100	110
Druck (BAR)	200/220	200/220	200/220	200/220	200/220	200/220	200/220	200/220	200/220
Vibrationsfrequenz (RPM)	2.133	2.148	2.143	2.133	2.148	2.143	2.143	2.149	2.157
Zentrifugalkraft (Kn)	60	60	60	80	80	80	100	100	100
Hertz	36	36	36	36	36	36	36	36	36
Max. Gegendruck (BAR)	15	15	15	15	15	15	15	15	15

PLURY	W2 120.0	W2 120.0	W2 120.0	W2 150.0	W2 180.0
	TONS 14.0 - 20.0	TONS 14.0 - 20.0	TONS 14.0 - 20.0	TONS 18.0 - 35.0	TONS 20.0 - 40.0
A (mm)	1030	1030	1030	1220	1220
B (mm)	735	735	735	920	920
C (mm)	395	395	395	440	440
D (mm)	560	560	560	710	710
Gewicht (Kg)	533	533	533	827	837
Motor (CC)	43	47	51	63	63
Öldurchsatz (L/Min)	93	100	110	135	135
Druck (BAR)	200/220	200/220	200/220	250/300	250/300
Vibrationsfrequenz (RPM)	2.143	2.149	2.157	2.143	2.143
Zentrifugalkraft (Kn)	120	120	120	150	180
Hertz	36	36	36	36	36
Max. Gegendruck (BAR)	15	15	15	15	15