



 **VORTEX**

**ERDBOHRER
MULTIFUNKTION**

ERDBOHRER VIELSEITIGER BOHRER
DER BOHRER KANN MIT VERSCHIEDENEN
ARTEN VON SPITZEN UND
VERLÄNGERUNGEN AUSGESTATTET
WERDEN, MIT DENEN SIE EINE
SFÜHREN KÖNNEN, VOM BOHREN DES
BODENS BIS ZUM ZERKLEINERN VON
WURZELN UND BAUMSTÜMPFEN

VORTEX

 VIDEO



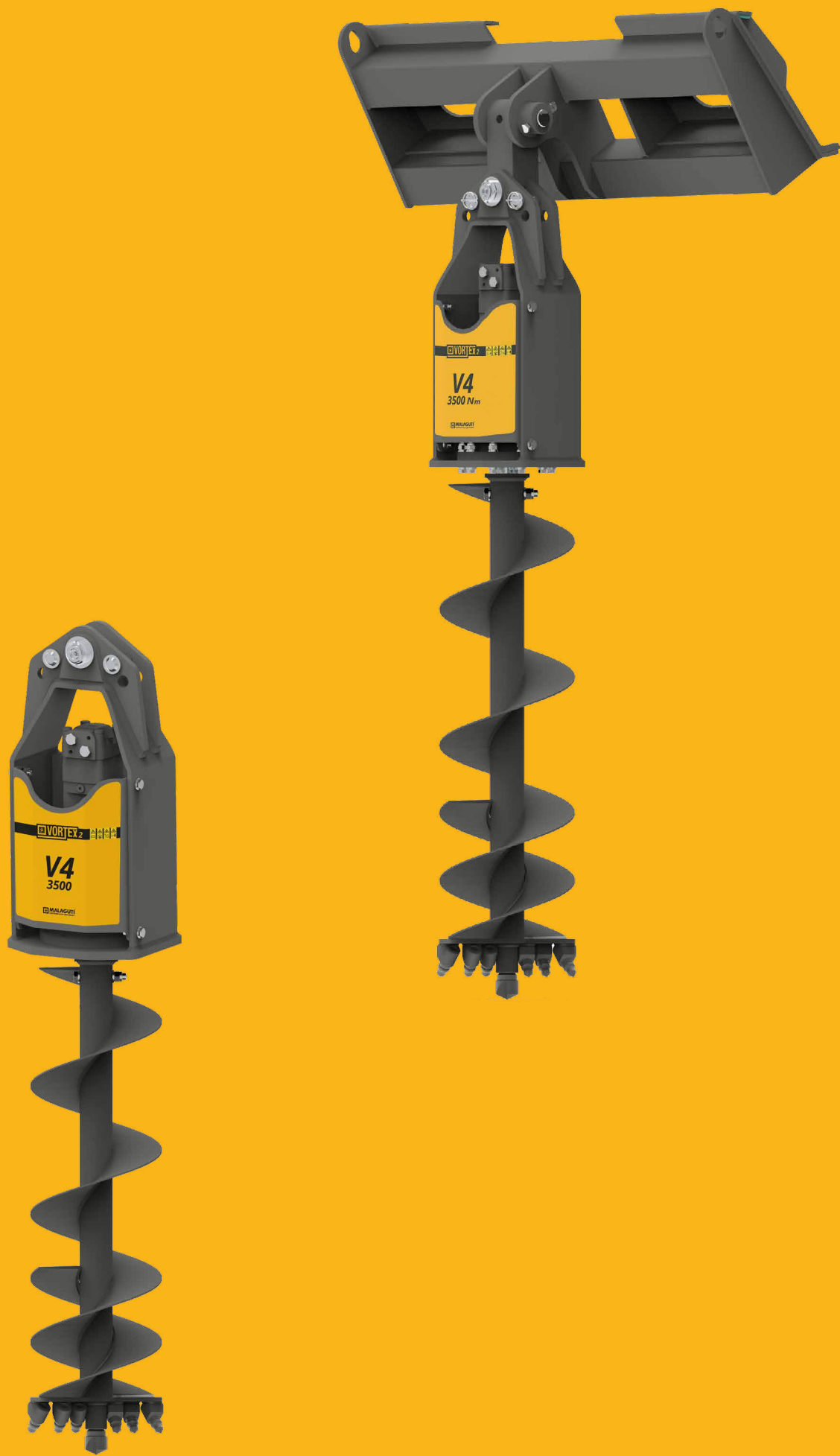

VORTEX 2

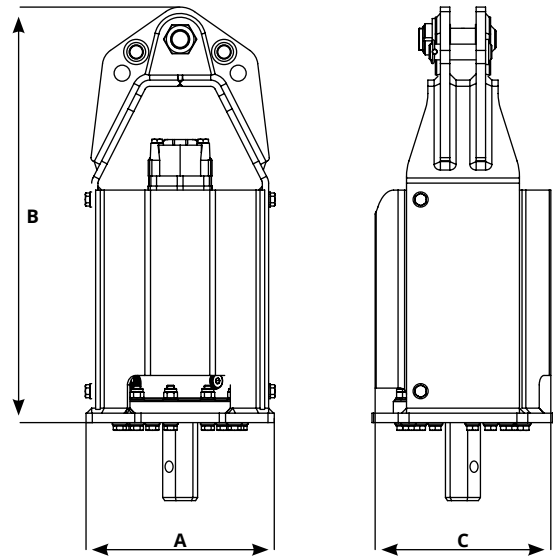

Tons	1.0 - 1.8	1.8 - 2.2	2.0 - 3.0	3.0 - 4.5	4.0 - 6.0	6.0 - 7.5	7.0 - 10.0	10.0 - 15.0	15.0 - 20.0
MODEL	V1	V2	V3	V4	V5	V6	V7	V8	V9
A (mm)	235	235	235	300	300	360	360	410	410
B (mm)	475	475	475	660	660	780	780	950	950
C (mm)	230	230	230	290	290	350	350	430	430
SCHLÜSSEL	50	50	50	50	50	70	70	70	70
Gewicht ohne Kupplung Kg	59	62	62	100	105	180	180	260	283
Kapazität Min/Max (L/1')	20-30	25-40	30-50	40-60	50-70	60-80	80-90	90-120	110-150
Drunk Bar	220	220	220	220	220	220	220	240	280
Max. Drehmoment N/m	1.200	1.600	2.500	3.500	4.500	6.200	8.000	10.000	15.000



VORTEX 2F

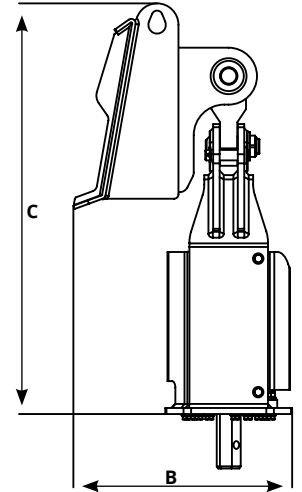
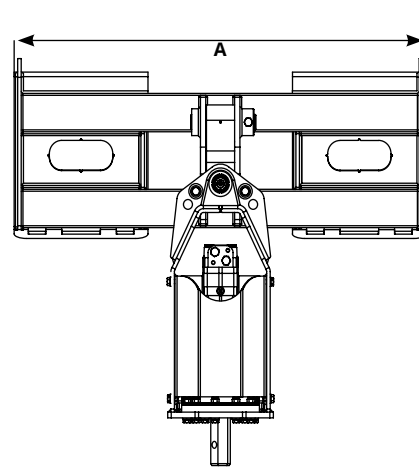

MODEL	V1	V2	V3	V4	V5
A (mm)	1170	1170	1170	1170	1170
B (mm)	470	470	470	500	500
C (mm)	750	750	750	935	935
⊗ SCHLÜSSEL	50	50	50	50	50
Gewicht mit Aufnahme Kg	244	247	247	285	290
Kapazität Min/Max (L/1')	20-30	25-40	30-50	40-60	50-70
Drunk Bar	220	220	220	220	220
Max. Drehmoment N/m	1.200	1.600	2.500	3.500	4.500



Model
COUPLING TO LOADER
Zubehör für Schaufeln



LOG SPLITTER CONICAL BIT



KONUS ZUM AUFBRECHEN VON WURZELSTÖCKEN

› Ideal zum zerteilen von baumstämmen

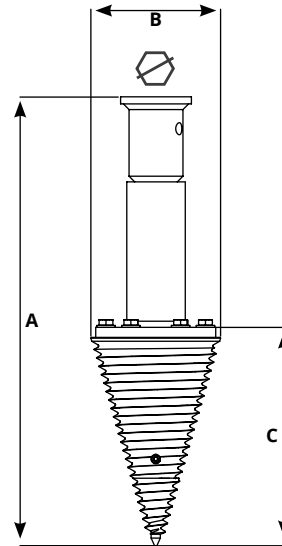

SCHLÜSSEL	50	70
MODEL VORTEX	V1 - V2 - V3 - V4 - V5	V6 - V7 - V8 - V9
A (mm)	550	775
B (mm)	170	220
C (mm)	305	390
Kg	23	48

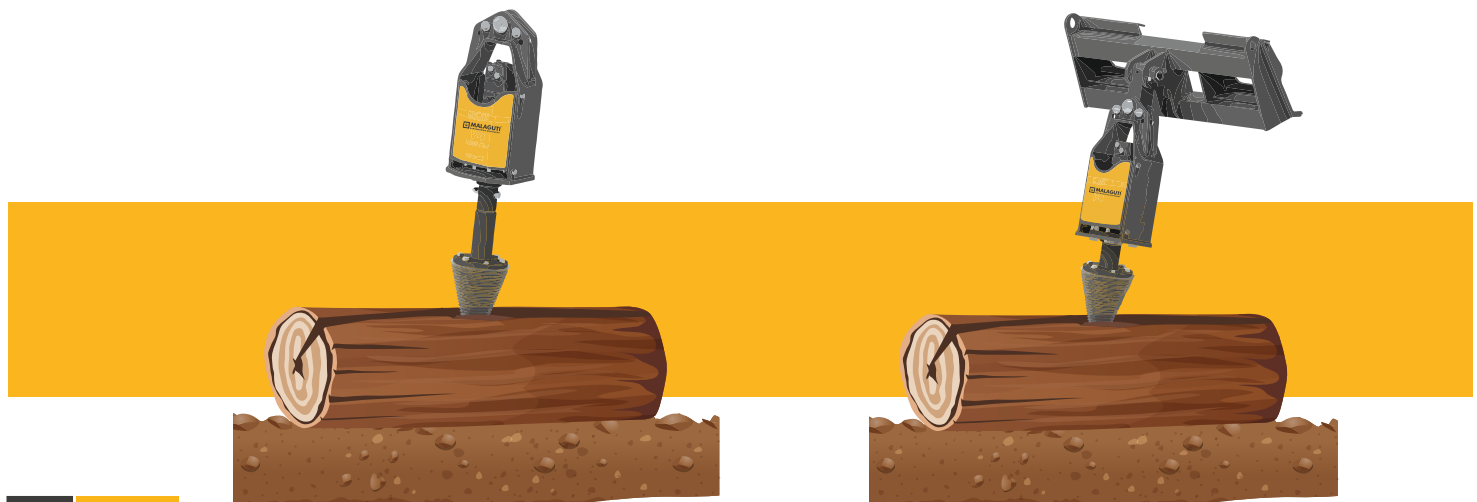



STUMP GRINDER BIT



FORET BROYEUR DE SOUCHES

› Konus zum aufbrechen von wurzelstöcken

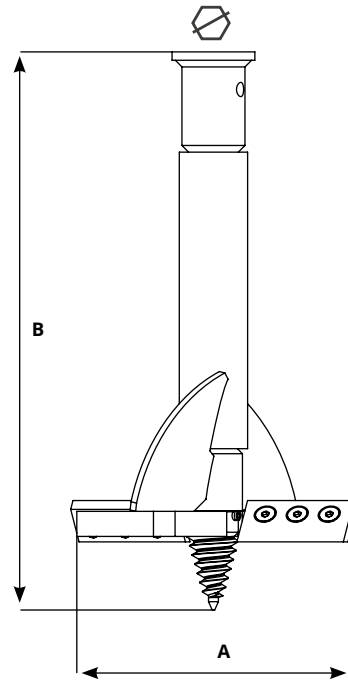
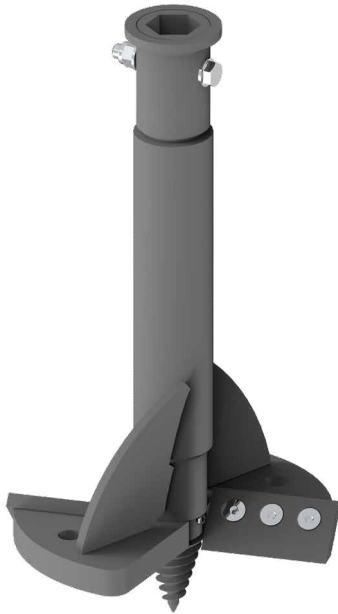

SCHLÜSSEL	50	70
MODEL VORTEX	V1 - V2 - V3 - V4 - V5	V6 - V7 - V8 - V9
A (mm)	330	330
B (mm)	670	700
Kg	29	33



BIT SHAFT EXTENSIONS



VERLÄNGERUNGEN OHNE SPIRALE FÜR SPITZEN

- › Durch die verlängerung kann der bohrer tiefer gebohrt werden

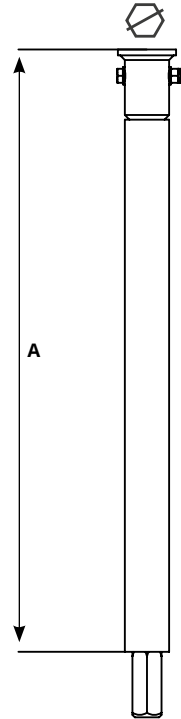

SCHLÜSSEL	50	70
A (mm)	1000	1000
Kg	20	25

SCHLÜSSEL	50	70
A (mm)	1500	1500
Kg	28	33

SCHLÜSSEL	50	70
A (mm)	2000	2000
Kg	36	42



BIT EXTENSIONS WITH SPIRAL



VERLÄNGERUNGEN MIT SPIRALE FÜR SPITZEN

Geeignet zur Erhöhung der Arbeitstiefe während des Bohrvorgangs

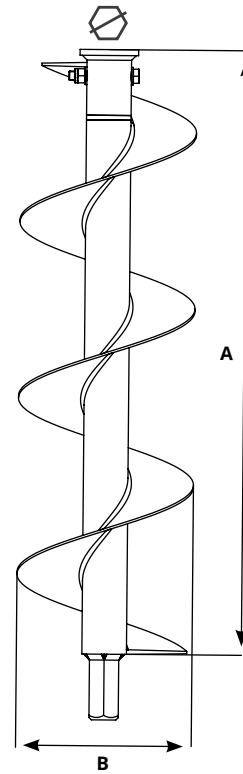

SCHLÜSSEL \varnothing 50 (A) 1000mm

B (mm)	100	150	200	250	300	350	400	500	600
Kg	22	25	27	28	30	35	37	50	55

SCHLÜSSEL \varnothing 70 (A) 1000mm

B (mm)	100	150	200	250	300	350	400	500	600
Kg	/	30	32	33	35	40	42	55	60

SCHLÜSSEL \varnothing 50 (A) 2000mm

B (mm)	100	150	200	250	300	350	400	500	600
Kg	40	46	50	53	57	66	70	97	107

SCHLÜSSEL \varnothing 70 (A) 2000mm

B (mm)	100	150	200	250	300	350	400	500	600
Kg	/	51	55	58	62	71	75	102	112



LAND BIT



SPITZE FÜR ERDE

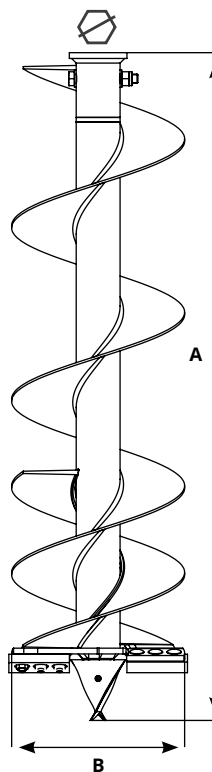
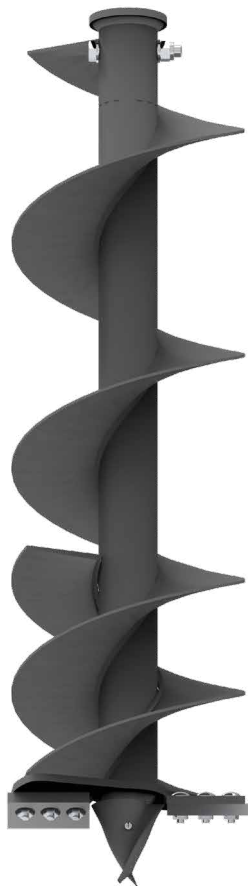

SCHLÜSSEL \varnothing 50 (A) 1000mm									
B (mm)	100	150	200	250	300	350	400	500	600
Kg	21	25	29	32	35	43	47	68	80

SCHLÜSSEL \varnothing 70 (A) 1000mm									
B (mm)	100	150	200	250	300	350	400	500	600
Kg	/	28	32	34	38	45	50	70	83



ROCK BIT



BOHRER FÜR FELS

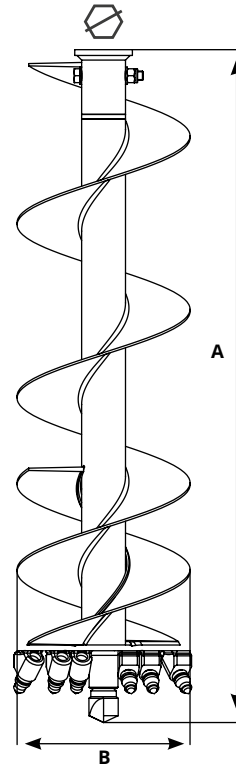
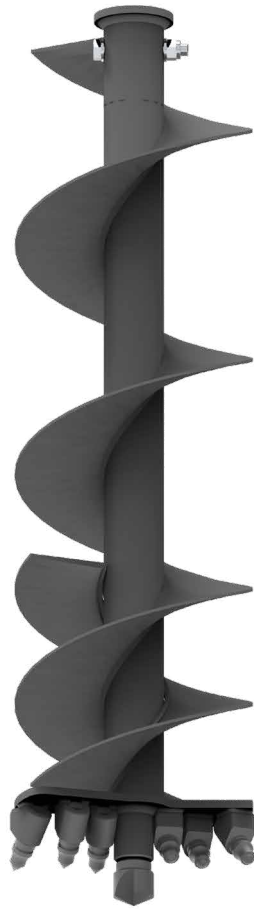

SCHLÜSSEL \varnothing 50 (A) 1000mm

B (mm)	100	150	200	250	300	350	400	500	600
Kg	21	26	31	33	37	46	50	71	84

SCHLÜSSEL \varnothing 70 (A) 1000mm

B (mm)	100	150	200	250	300	350	400	500	600
Kg	/	29	33	36	40	48	52	74	87



LAND BIT EXTRA



EXTRA ERDBOHRER

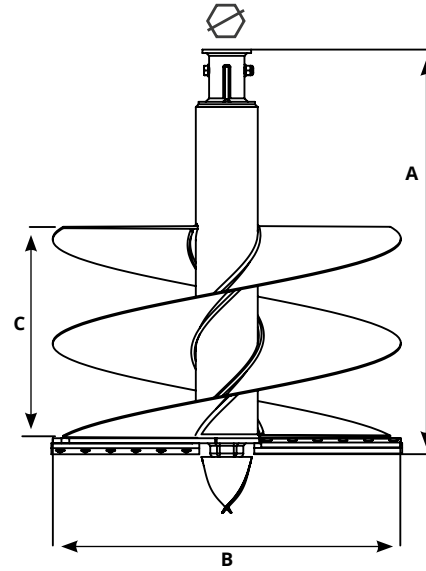
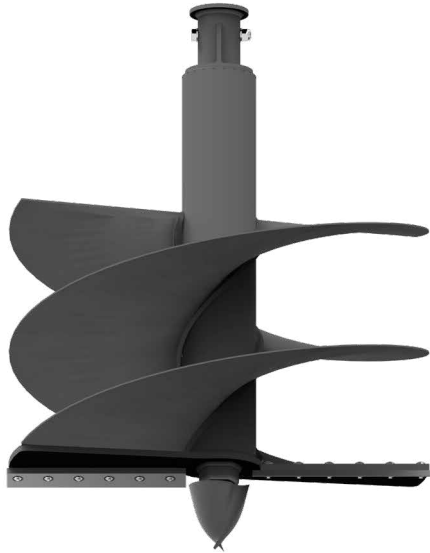

SCHLÜSSEL	50	50	70	70
MODEL VORTEX	V1 - V2 - V3 - V4 - V5	V1 - V2 - V3 - V4 - V5	V6 - V7 - V8 - V9	V6 - V7 - V8 - V9
A (mm)	1000	1000	1000	1000
B (mm)	800	1000	800	1000
C (mm)	600	600	600	600
Kg	138	180	140	183



ROCK BIT EXTRA



EXTRA BOHRER FÜR FELS

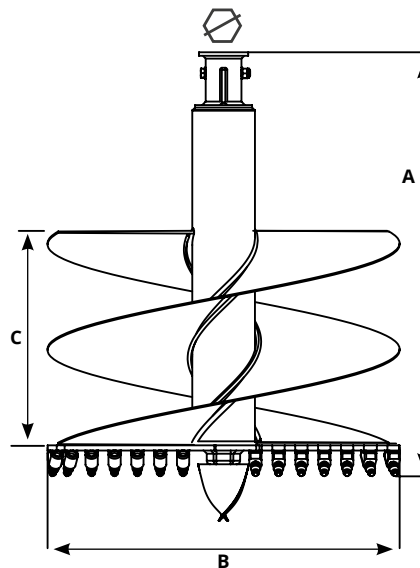
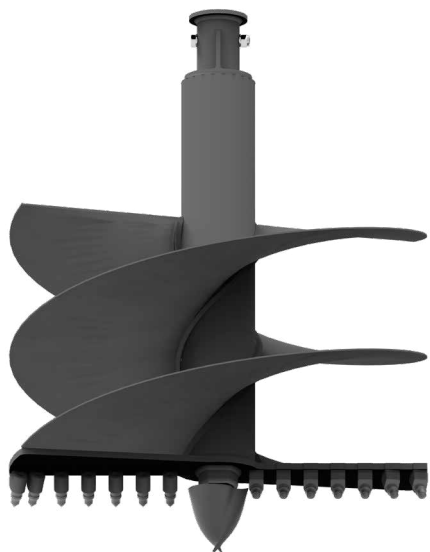

SCHLÜSSEL	50	50	70	70
MODEL VORTEX	V1 - V2 - V3 - V4 - V5	V1 - V2 - V3 - V4 - V5	V6 - V7 - V8 - V9	V6 - V7 - V8 - V9
A (mm)	1000	1000	1000	1000
B (mm)	800	1000	800	1000
C (mm)	600	600	600	600
Kg	142	144	188	191

SINGLE PIN ATTACHMENT



EINZELSTIFTAUFNAHME



MODEL VORTEX	V1	V2 - V3	V4 - V5	V6 - V7	V8 - V9
Kg	15	20	25	40	60

DOUBLE JOINT ATTACHMENT



DOPPELKUPPLUNG

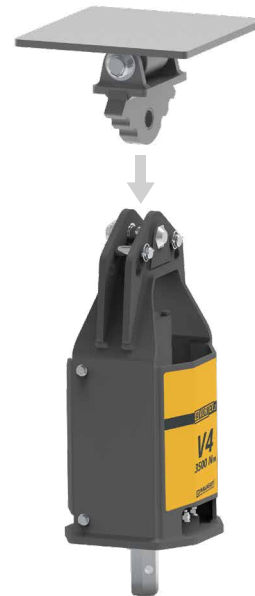

MODEL VORTEX	V1	V2 - V3	V4 - V5	V6 - V7	V8 - V9
Kg	25	26	35	65	86

Quick coupler / Fixed attachment	✓	✓	✓	✓	✓
----------------------------------	---	---	---	---	---

HORIZONTAL ATTACHMENT



HORIZONTALAUFNAHME



MODEL VORTEX	V1	V2 - V3	V4 - V5	V6 - V7	V8 - V9
Kg	31	32	40	75	96
Quick coupler / Fixed attachment	✓	✓	✓	✓	✓

RIGID ATTACHMENT



STARRE AUFNAHME

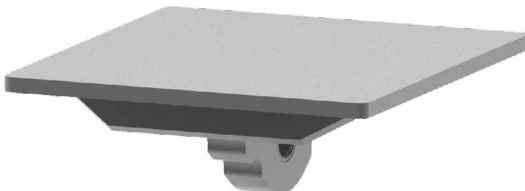

MODEL VORTEX	V1	V2 - V3	V4 - V5	V6 - V7	V8 - V9
Kg	15	16	25	33	55
Quick coupler / Fixed attachment	✓	✓	✓	✓	✓



AUGER BIT ADAPTER



ADAPTER FÜR BOHRSPITZEN

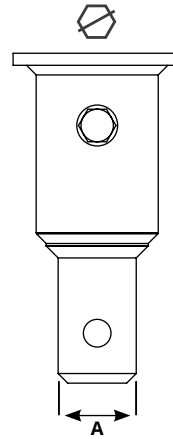

SCHLÜSSEL	50	50	70
A (mm)	50	65	65
Kg	5	6	9

CUBIC ADAPTER FOR AUGER BIT



KUBISCHER ADAPTER FÜR BOHRSPITZEN

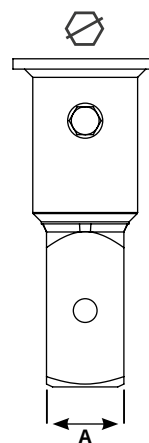

SCHLÜSSEL	70
A (mm)	50
Kg	13



ANCHOR ADAPTER



ADAPTER FÜR ANKER

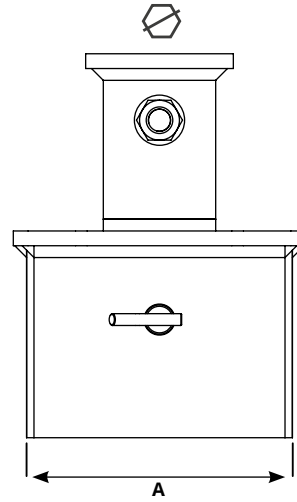
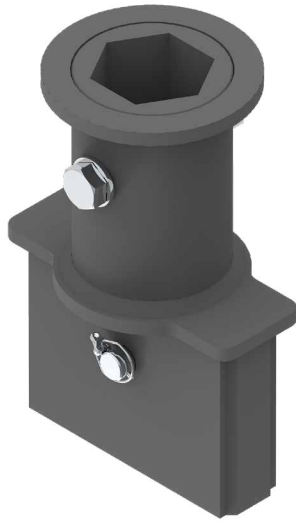

 SCHLÜSSEL	50	70
A (mm)	50	65
Kg	8	11



GENERAL SALES INFORMATION

THE FOLLOWING GENERAL SALES CONDITIONS ARE BINDING AND FORM AN INTEGRAL PART OF THE CONTRACTS CONCLUDED BETWEEN THE SELLER AND THE BUYER FOR THE SUPPLY OF THE SELLER'S PRODUCTS (THE "PRODUCTS").

THESE SALES CONDITIONS APPLY TO ALL TRANSACTIONS CONCLUDED WITH THE SELLER AND THE BUYER WITHOUT THE NEED FOR EXPLICIT REFERENCE TO THEM OR A SPECIFIC AGREEMENT IN THIS REGARD AT THE CONCLUSION OF EACH INDIVIDUAL TRANSACTION. ANY DIFFERENT CONDITION OR TERM WILL APPLY ONLY IF CONFIRMED IN WRITING BY THE SELLER.

THE SELLER RESERVES THE RIGHT TO MODIFY, SUPPLEMENT, OR AMEND THE GENERAL SALES CONDITIONS, ATTACHING SUCH VARIATIONS TO OFFERS OR ANY WRITTEN CORRESPONDENCE SENT TO THE BUYER.

OFFERS AND ORDERS

The Seller's offers are not binding, especially concerning quantity, prices, and delivery terms. Orders placed by the Buyer are not considered accepted until they are confirmed in writing by the Seller. The Buyer has the option to modify and/or cancel the order within 24 hours of receipt, as expressly stated in the order confirmation. Orders and/or order modifications made verbally or over the phone must be confirmed in writing by the Buyer; otherwise, the Seller assumes no responsibility for any errors or misunderstandings.

PRICES AND PAYMENT TERMS

The price of the products and spare parts, if not indicated in the order confirmation, is the one established in the 4.0 price list in effect at the time of the order. Product prices do not include VAT, which must be paid at the time of delivery or in accordance with the specific provisions indicated on the invoice. Taxes, duties, shipping, insurance, after-sales service are not included in the prices unless separately quoted. In case of delayed or non-payment within the agreed terms, the Seller has the right to apply late payment interest, in addition to seeking compensation for any other damages suffered, as well as suspend and/or cancel further deliveries and demand immediate payment of the outstanding amount. The Parties hereby agree that in the event of disputes between them relating to this contract, the Buyer may not, for any reason, delay and/or suspend payments for executed orders. In the event of changes in the Buyer's economic conditions, the Seller may request immediate payment with forfeiture of the grace period, change payment terms, including a request for total or partial prepayment before shipment. In any case, the Buyer is not entitled to make offsetting, deductions, or reductions of the price and/or sums due to the Seller, unless there is written consent from the Seller.

DELIVERY TERMS

Unless otherwise agreed in writing, any indicated delivery term is not binding on the Seller. Unless otherwise agreed between the parties, the indicative delivery term is specified in the order confirmation. The delivery terms and methods of the product and/or spare parts are those indicated by the Seller in the order confirmation; it is understood that the Seller is not responsible for delays due to force majeure, acts of third parties, public authorities, or causes attributable to the Buyer, as expressly regulated in article 1341 of the Civil Code. The Seller is not obligated to accept returns of products unless expressly agreed in writing. Any costs incurred for this purpose are borne by the Buyer.

WARRANTY TERMS

- a) The Seller guarantees that the products and/or spare parts are free from defects and conform to the technical specifications stated in the product technical manuals and documentation provided to the Buyer.
- b) The warranty is valid for 12 months from the date the Product and/or spare parts and/or Product parts leave the Seller's premises.
- c) The Seller is not liable, even towards third parties, for improper use and non-compliance with what is indicated in the user and maintenance manuals for the products and/or spare parts, as well as for use by untrained personnel.
- d) Tampering with the product and/or spare parts or any maintenance and/or repair work on it, or replacement of parts not authorized in writing by the Seller, results in the forfeiture of the warranty.
- e) It is the Buyer's obligation to check the packaging, quantity, and conformity of the products and/or spare parts at the time of delivery, recording any discrepancies in the Delivery Note.
- f) Any defects or non-conformities of the products and/or spare parts must be reported in writing to the Seller within 8 days of receipt, including a detailed report and photographic documentation of the complaints and a copy of the Delivery Note with the complaints already indicated therein.
- g) Catalogs, price lists, and promotional materials provided by the Seller, containing images and indicative descriptions of the product, cannot be used as evidence of non-compliance with the Product itself.
- h) Once it is verified that the product reported as defective falls within the warranty condition, Malaguti srl may decide how to intervene, ensuring the problem is resolved as quickly as possible.
- i) All products and/or spare parts, even in replacement, or sent before the warranty is verified, will be shipped with a sales Delivery Note and billed to the Buyer. After appropriate checks, in the case of replacement falling within the warranty condition, the Seller will issue a credit note.
- l) This warranty condition does not cover any damages to the Customer or third parties, direct or indirect damages, loss of profits, accidental damages, commercial damages, production delays, damage to reputation, and any other costs incurred by the Buyer and internal management expenses. The warranty also does not cover travel expenses for the shipment of products and/or spare parts.
- m) The Seller reserves the right to send the Buyer a replacement product and/or spare part for the period necessary for any checks and repairs.



LIMITATION OF LIABILITY

Except in cases of justified dispute, the Buyer is not entitled to any further rights or remedies. In particular, the Seller is not liable for any compensation claimed for breach or non-performance of the contract, for any direct damage, or loss of profit suffered by the Buyer as a result of the use, non-use, or installation of the Products in other products, except in cases covered by warranty as indicated in the previous paragraph or in cases of willful misconduct or gross negligence by the Seller. The Seller will make every effort to deliver the Products within the agreed-upon timeframe, but in no case shall the Seller be held responsible for damages directly or indirectly caused by delayed contract execution or delayed product delivery. The catalog, price list, or other promotional materials of the Seller only serve as an indication of the type of Products and prices, and the indications therein are not binding on the Seller. The Seller assumes no responsibility for errors or omissions in its own price list or promotional materials.

INTELLECTUAL PROPERTY OF MALAGUTI S.R.L.

The Customer expressly acknowledges that the trademarks, trade names, or other distinctive signs affixed to the goods are the exclusive property of Malaguti s.r.l. and may not be altered, modified, removed, or deleted in any way. The Customer has the limited right to use the trademark, trade names, or other distinctive signs, as well as any other industrial property or production and commercial know-how incorporated in the goods, for the sole and limited purpose of reselling the goods to the public. Any different use of Malaguti s.r.l.'s intellectual property by the Customer, unless expressly granted by Malaguti s.r.l. in writing, shall be deemed a violation by the Customer of the aforementioned exclusive rights of Malaguti s.r.l., also from a contractual liability perspective, and will be properly pursued. Documents, drawings, data, and information (whether in paper form or electronically) that are delivered to the Customer remain the exclusive property of Malaguti s.r.l. and serve as support for a better representation of the Product and are indicative of the Product's performance. The Customer agrees not to reproduce them, disclose them to third parties, and also to take appropriate precautions with respect to its personnel to ensure their protection.

PERSONAL DATA PROCESSING

- a) The personal data of the Buyer will be processed in accordance with Italian law on personal data processing, including GDPR and Legislative Decree 101/2018 and subsequent amendments. The Seller informs the Buyer that the Seller is the data controller, and the personal data of the Buyer are collected and processed exclusively for the execution of this agreement.
- b) Data and information processed based on these general sales conditions may not in any way be disclosed to third parties, unless expressly authorized in writing by the Seller, except for legal obligations related to providing documents containing personal data to public authorities.
- c) Each Party undertakes to promptly report to the other any violation of trademark rights of which it becomes aware, as well as any other acts of unfair competition committed by third parties, in order to allow the injured Party to take the necessary or appropriate defensive actions in the common interest.

APPLICABLE LAW

- a) If the Buyer is a legal entity under Italian law, these General Sales Conditions and all contracts entered into by the Buyer with the Seller shall be governed by Italian law.
- b) If, on the other hand, the Buyer is a national of a country other than Italy, these General Sales Conditions and all contracts entered into by the Buyer with the Seller shall be governed by the 1980 United Nations Convention on Contracts for the International Sale of Goods (CISG).

JURISDICTION

- a) All disputes arising from this contract shall be exclusively submitted to the jurisdiction of the Forlì Court.
- It is understood between the Parties that only the Seller, at its discretion, shall have the right to waive the jurisdiction of the exclusive court as indicated in the preceding paragraph a) to take legal action against the Buyer at its domicile or at the competent court.

GENERAL PROVISIONS

- a) The invalidity in whole or in part of individual provisions of these General Sales Conditions shall not affect the validity of the remaining provisions.
- b) Any modification or addition to this contract must be made in writing and duly signed by the parties.
- c) These General Sales Conditions are drafted in both Italian and English. In case of interpretative doubts, the Italian version shall prevail.





 **Officine Malaguti SRL**
Sant'Agata Bolognese (BO)
Italy

Ufficio Commerciale
 +39 0547 1932186
 commerciale@malagutisrl.com

 Piazza Plauto, 40
47027 Sarsina (FC)
Italy

 www.malagutisrl.com

